

1000 Gallon Single Compartment Septic Tank

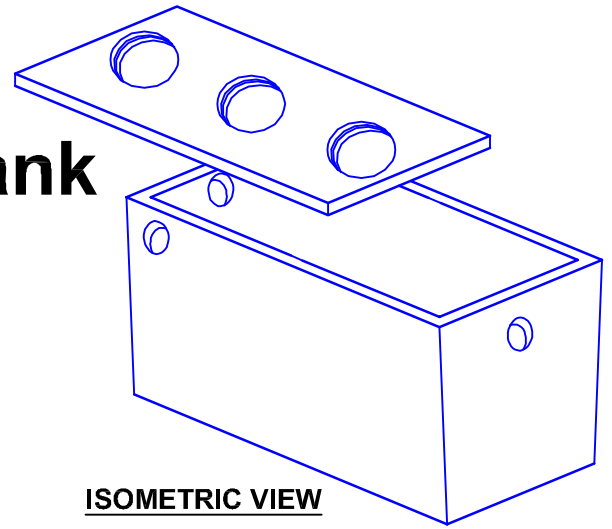

ISOMETRIC VIEW

TANK SPECIFICATION CONFORMS TO LATEST ASTM DESIGNATION C1222

NOTES:

1. JOINT SEALANT IS BUTYL RUBBER MASTIC TYPE SEAL
2. PIPE INLET AND OUTLET LOCATIONS HAVE POLYLOK II PIPE SEALS.
3. REINFORCING STEEL DEFORMED BARS CONFORM TO LATEST ASTM SPECIFICATION A615.
4. CONCRETE COMPRESSIVE STRENGTH - 5000PSI @ 28 DAYS.
5. METHOD OF MANUFACTURER; WET CAST.
6. SECTIONS ARE MONOLITHIC

WEIGHT CHART:

PRODUCT	APPROX WEIGHT
TANK	9,200 LBS

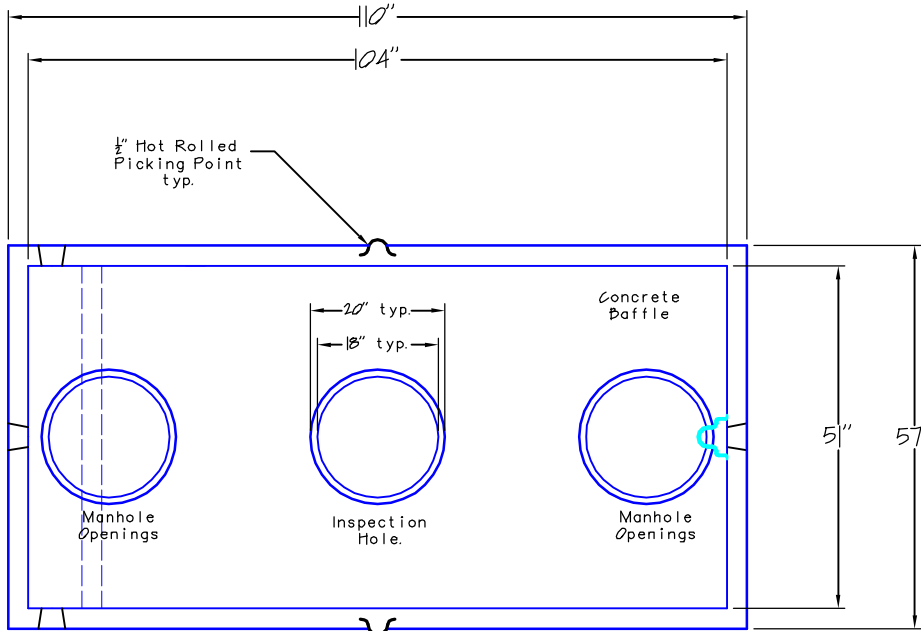

TOP VIEW

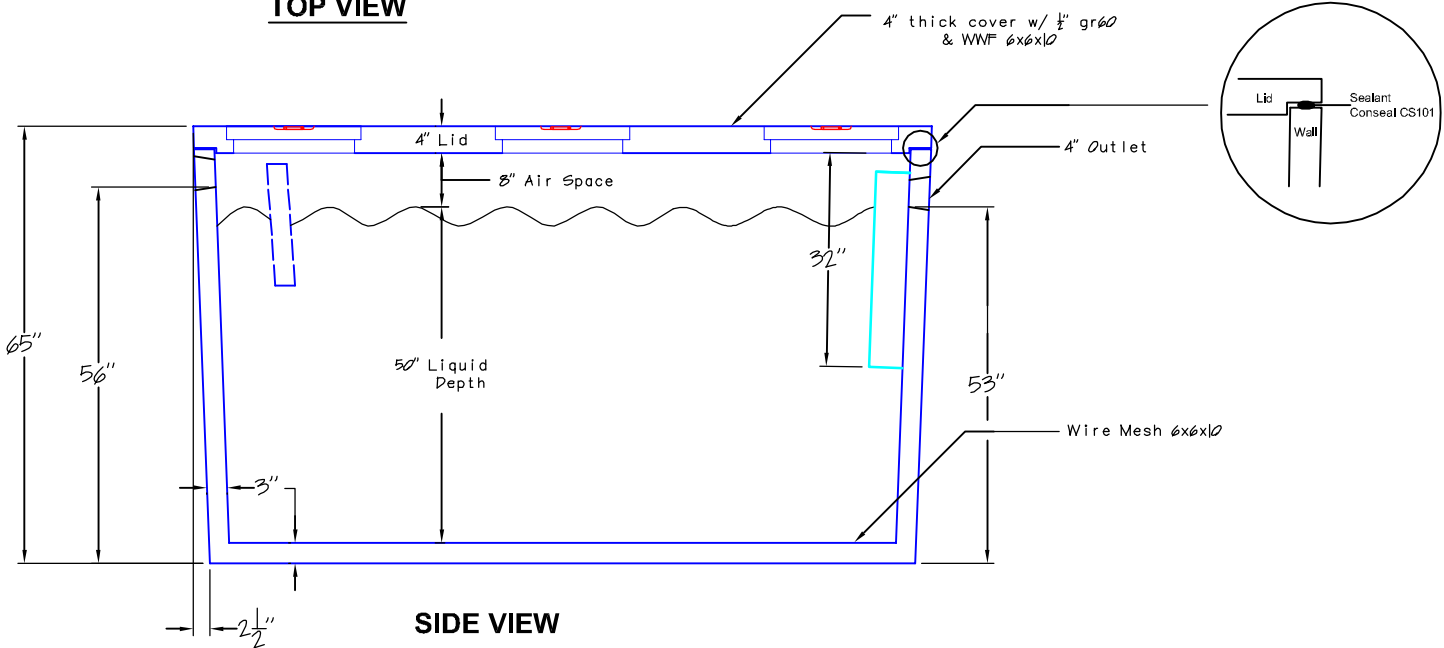

SIDE VIEW

Arnold Pre-Cast, Inc.

129 West Street
Malone, New York 12953

518-651-2500
518-651-2502 fax